

S-MADI REAC MADI BRIDGE

Owner's Manual

Before using this unit, carefully read the sections entitled: "IMPORTANT SAFETY INSTRUCTIONS" (p.2), "USING THE UNIT SAFELY" (p. 4), and "IMPORTANT NOTES" (p. 6). These sections provide important information concerning the proper operation of the unit. Additionally, in order to feel assured that you have gained a good grasp of every feature provided by your new unit, Owner's Manual should be read in its entirety. The manual should be saved and kept on hand as a convenient reference.





Copyright © 2010 ROLAND CORPORATION

All rights reserved. No part of this publication may be reproduced in any form without the written permission of ROLAND CORPORATION.



WARNING: To reduce the risk of fire or electric shock, do not expose this apparatus to rain or moisture.

	CAUTION RISK OF ELECTRIC SHOCK DO NOT OPEN	
ATTENTION: RISQUE DE CHOC ELECTRIQUE NE PAS OUVRIR		
CAUTION: TO REDUCE THE RISK OF ELECTRIC SHOCK, DO NOT REMOVE COVER (OR BACK). NO USER-SERVICEABLE PARTS INSIDE. REFER SERVICING TO QUALIFIED SERVICE PERSONNEL.		



The lightning flash with arrowhead symbol, within an equilateral triangle, is intended to alert the user to the presence of uninsulated "dangerous voltage" within the product's enclosure that may be of sufficient magnitude to constitute a risk of electric shock to persons.



The exclamation point within an equilateral triangle is intended to alert the user to the presence of important operating and maintenance (servicing) instructions in the literature accompanying the product.

INSTRUCTIONS PERTAINING TO A RISK OF FIRE, ELECTRIC SHOCK, OR INJURY TO PERSONS.

IMPORTANT SAFETY INSTRUCTIONS SAVE THESE INSTRUCTIONS

WARNING - When using electric products, basic precautions should always be followed, including the following:

1. Read these instructions.
2. Keep these instructions.
3. Heed all warnings.
4. Follow all instructions.
5. Do not use this apparatus near water.
6. Clean only with a dry cloth.
7. Do not block any of the ventilation openings. Install in accordance with the manufacturers instructions.
8. Do not install near any heat sources such as radiators, heat registers, stoves, or other apparatus (including amplifiers) that produce heat.
9. Do not defeat the safety purpose of the polarized or grounding-type plug. A polarized plug has two blades with one wider than the other. A grounding type plug has two blades and a third grounding prong. The wide blade or the third prong are provided for your safety. If the provided plug does not fit into your outlet, consult an electrician for replacement of the obsolete outlet.
10. Protect the power cord from being walked on or pinched particularly at plugs, convenience receptacles, and the point where they exit from the apparatus.
11. Only use attachments/accessories specified by the manufacturer.
12. Unplug this apparatus during lightning storms or when unused for long periods of time.
13. Refer all servicing to qualified service personnel. Servicing is required when the apparatus has been damaged in any way, such as power-supply cord or plug is damaged, liquid has been spilled or objects have fallen into the apparatus, the apparatus has been exposed to rain or moisture, does not operate normally, or has been dropped.

For the U.K.

WARNING: THIS APPARATUS MUST BE EARTHED

IMPORTANT: THE WIRES IN THIS MAINS LEAD ARE COLOURED IN ACCORDANCE WITH THE FOLLOWING CODE.
GREEN-AND-YELLOW: EARTH, BLUE: NEUTRAL, BROWN: LIVE

As the colours of the wires in the mains lead of this apparatus may not correspond with the coloured markings identifying the terminals in your plug, proceed as follows:

The wire which is coloured GREEN-AND-YELLOW must be connected to the terminal in the plug which is marked by the letter E or by the safety earth symbol  or coloured GREEN or GREEN-AND-YELLOW.

The wire which is coloured BLUE must be connected to the terminal which is marked with the letter N or coloured BLACK.

The wire which is coloured BROWN must be connected to the terminal which is marked with the letter L or coloured RED.

For the USA

DECLARATION OF CONFORMITY Compliance Information Statement

Model Name : S-MADI
Type of Equipment : Signal Converter
Responsible Party : Roland Systems Group U.S.
Address : 801 West Orchard Drive, Suite 3, Bellingham, WA 98225
Telephone : (360)594-4282

Check the included items

The following items are included. Please make sure that all items are present. If anything is missing, please contact your dealer.

S-MADI itself



Ferrite core (two)



Power Cord



Rubber foot (four)

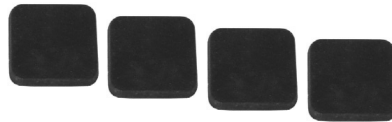

REAC connector cover (two)

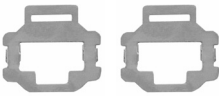

Owner's Manual (this document)



What's REAC ?

REAC (Roland Ethernet Audio Communication) is a proprietary audio-signal transmission protocol from Roland that is based on Ethernet technology. It provides transmission of uncompressed 24-bit audio signals up to 40 channels. REAC devices are connected using Cat 5e (Enhanced Category 5) Ethernet cable.

What's MADI ?

MADI (Multichannel Audio Digital Interface) is a standard of digital audio transmission standardized by AES. It is an expansion of AES/EBU which provides stereo (2 channels) transmission. MADI can transmit up to 64 channels of audio signal through one cable.

MMP (Moore Microprocessor Portfolio) refers to a patent portfolio concerned with microprocessor architecture that was developed by Technology Properties Limited (TPL). Roland has licensed this technology from the TPL Group.



* Roland and REAC are either registered trademarks or trademarks of Roland Corporation in the United States and/or other countries.

* All product names mentioned in this document are trademarks or registered trademarks of their respective owners.



USING THE UNIT SAFELY

INSTRUCTIONS FOR THE PREVENTION OF FIRE, ELECTRIC SHOCK, OR INJURY TO PERSONS

About ⚠ WARNING and ⚠ CAUTION Notices

 WARNING	Used for instructions intended to alert the user to the risk of death or severe injury should the unit be used improperly.
 CAUTION	Used for instructions intended to alert the user to the risk of injury or material damage should the unit be used improperly. * Material damage refers to damage or other adverse effects caused with respect to the home and all its furnishings, as well to domestic animals or pets.

About the Symbols

	The ⚠ symbol alerts the user to important instructions or warnings. The specific meaning of the symbol is determined by the design contained within the triangle. In the case of the symbol at left, it is used for
	The ⊘ symbol alerts the user to items that must never be carried out (are forbidden). The specific thing that must not be done is indicated by the design contained within the circle. In the case of the symbol at left, it means that the unit must never be disassembled.
	The ● symbol alerts the user to things that must be carried out. The specific thing that must be done is indicated by the design contained within the circle. In the case of the symbol at left, it means that the power-cord plug must be unplugged from the outlet.



ALWAYS OBSERVE THE FOLLOWING

⚠ WARNING

- Connect mains plug of this model to a mains socket outlet with a protective earthing connection. 

- Do not open or perform any internal modifications on the unit. 

- Do not attempt to repair the unit, or replace parts within it (except when this manual provides specific instructions directing you to do so). Refer all servicing to your retailer, the nearest Roland Service Center, or an authorized Roland distributor, as listed on the "Information" sheet. 

- Never install the unit in any of the following locations.
 - Subject to temperature extremes (e.g., direct sunlight in an enclosed vehicle, near a heating duct, on top of heat-generating equipment); or are 
 - Damp (e.g., baths, washrooms, on wet floors); or are 
 - Exposed to steam or smoke; or are
 - Subject to salt exposure; or are
 - Humid; or are
 - Exposed to rain; or are
 - Dusty or sandy; or are
 - Subject to high levels of vibration and shakiness.

- Make sure you always have the unit placed so it is level and sure to remain stable. Never place it on stands that could wobble, or on inclined surfaces. 

- Use only the attached power-supply cord. Also, the supplied power cord must not be used with any other device. 

- The unit should be connected to a power supply only of the type described in the operating instructions, or as marked on the side of the unit. 

⚠ WARNING

- Do not excessively twist or bend the power cord, nor place heavy objects on it. Doing so can damage the cord, producing severed elements and short circuits. Damaged cords are fire and shock hazards! 



- Do not place containers containing liquid (e.g., flower vases) on this product. Never allow foreign objects (e.g., flammable objects, coins, wires) or liquid (e.g., water or juice) to enter this product. Doing so may cause short circuits, faulty operation, or other malfunctions. 

- Immediately turn the power off, remove the power cord from the outlet, and request servicing by your retailer, the nearest Roland Service Center, or an authorized Roland distributor, as listed on the "Information" sheet when:
 - The power-supply cord or the plug has been damaged; or
 - If smoke or unusual odor occurs
 - Objects have fallen into, or liquid has been spilled onto the unit; or
 - The unit has been exposed to rain (or otherwise has become wet); or
 - The unit does not appear to operate normally or exhibits a marked change in performance.











- In households with small children, an adult should provide supervision until the child is capable of following all the rules essential for the safe operation of the unit. 

- Protect the unit from strong impact. (Do not drop it!) 

⚠ WARNING

- Do not force the unit's power-supply cord to share an outlet with an unreasonable number of other devices. Be especially careful when using extension cords—the total power used by all devices you have connected to the extension cord's outlet must never exceed the power rating (watts/amperes) for the extension cord. Excessive loads can cause the insulation on the cord to heat up and eventually melt through. 
- Before using the unit in a foreign country, consult with your retailer, the nearest Roland Service Center, or an authorized Roland distributor, as listed on the "Information" sheet. 

⚠ CAUTION

- The unit should be located so that its location or position does not interfere with its proper ventilation. 
- Always grasp only the plug on the power-supply cord when plugging into, or unplugging from, an outlet or this unit. 
- At regular intervals, you should unplug the power plug and clean it by using a dry cloth to wipe all dust and other accumulations away from its prongs. Also, disconnect the power plug from the power outlet whenever the unit is to remain unused for an extended period of time. Any accumulation of dust between the power plug and the power outlet can result in poor insulation and lead to fire. 
- Try to prevent cords and cables from becoming entangled. Also, all cords and cables should be placed so they are out of the reach of children. 
- Never climb on top of, nor place heavy objects on the unit. 
- Never handle the power cord or its plugs with wet hands when plugging into, or unplugging from, an outlet or this unit. 
- Before moving the unit, disconnect the power plug from the outlet, and pull out all cords from external devices. 
- Before cleaning the unit, turn off the power and unplug the power cord from the outlet (p. 8). 
- Whenever you suspect the possibility of lightning in your area, pull the plug on the power cord out of the outlet. 
- Keep any screws or connector covers you may remove and the included connector covers, ferrite cores or rubber feet in a safe place out of children's reach, so there is no chance of them being swallowed accidentally. 
- The top panel and rear panel of this unit may become hot, so take care to avoid burns. 

IMPORTANT NOTES

Power Supply

- Do not connect this unit to same electrical outlet that is being used by an electrical appliance that is controlled by an inverter (such as a refrigerator, washing machine, microwave oven, or air conditioner), or that contains a motor. Depending on the way in which the electrical appliance is used, power supply noise may cause this unit to malfunction or may produce audible noise. If it is not practical to use a separate electrical outlet, connect a power supply noise filter between this unit and the electrical outlet.
- Before connecting this unit to other devices, turn off the power to all units. This will help prevent malfunctions and/or damage to speakers or other devices.
- Although the LEDs are switched off when the POWER switch is switched off, this does not mean that the unit has been completely disconnected from the source of power. If you need to turn off the power completely, first turn off the POWER switch, then unplug the power cord from the power outlet. For this reason, the outlet into which you choose to connect the power cord's plug should be one that is within easy reach and readily accessible.

Placement

- This device may interfere with radio and television reception. Do not use this device in the vicinity of such receivers.
- Noise may be produced if wireless communications devices, such as cell phones, are operated in the vicinity of this unit. Such noise could occur when receiving or initiating a call, or while conversing. Should you experience such problems, you should relocate such wireless devices so they are at a greater distance from this unit, or switch them off.
- Do not expose the unit to direct sunlight, place it near devices that radiate heat, leave it inside an enclosed vehicle, or otherwise subject it to temperature extremes. Excessive heat can deform or discolor the unit.
- When moved from one location to another where the temperature and/or humidity is very different, water droplets (condensation) may form inside the unit. Damage or malfunction may result if you attempt to use the unit in this condition. Therefore, before using the unit, you must allow it to stand for several hours, until the condensation has completely evaporated.
- Depending on the material and temperature of the surface on which you place the unit, its rubber feet may discolor or mar the surface. You can place a piece of felt or cloth under the rubber feet to prevent this from happening. If you do so, please make sure that the unit will not slip or move accidentally.
- Do not put anything that contains water (e.g., flower vases) on this unit. Also, avoid the use of insecticides, perfumes, alcohol, nail polish, spray cans, etc., near the unit. Swiftly wipe away any liquid that spills on the unit using a dry, soft cloth.

Maintenance

- For everyday cleaning wipe the unit with a soft, dry cloth or one that has been slightly dampened with water. To remove stubborn dirt, use a cloth impregnated with a mild, non-abrasive detergent. Afterwards, be sure to wipe the unit thoroughly with a soft, dry cloth.
- Never use benzene, thinners, alcohol or solvents of any kind, to avoid the possibility of discoloration and/or deformation.

Additional Precautions

- Please be aware that the contents of memory can be irretrievably lost as a result of a malfunction, or the improper operation of the unit. To protect yourself against the risk of losing important data, we recommend that you periodically write down save the important data you have stored in the unit's memory on paper.
- Use a reasonable amount of care when using the unit's buttons, sliders, or other controls; and when using its jacks and connectors. Rough handling can lead to malfunctions.
- When connecting / disconnecting all cables, grasp the connector itself—never pull on the cable. This way you will avoid causing shorts, or damage to the cable's internal elements.
- A small amount of heat will radiate from the unit during normal operation.
- When you need to transport the unit, package it in the box (including padding) that it came in, if possible. Otherwise, you will need to use equivalent packaging materials.
- When turning the unit upside-down, get a bunch of newspapers or magazines, and place them under the four corners or at both ends to prevent damage to the buttons and controls. Also, you should try to orient the unit so no buttons or controls get damaged.
- When turning the unit upside-down, handle with care to avoid dropping it, or allowing it to fall or tip over.

Contents

Power Supply	8
About Cord Hook.....	8
Turning the Power On and Off.....	9
Turning the Power On.....	9
Turning the Power Off.....	9
About Installation	10
Important Notes When Installing.....	10
Intake Port and Exhaust Port of Cooling Fan	10
About Rack Mounting	10
About Rubber Feet	11
Part Names and Functions	12
Front Panel	12
Rear Panel	14
Operating the SELECT Buttons	16
Connecting External Devices	17
Before Making MADI/REAC Connections	17
Connecting MADI/REAC Devices	19
Connection Example 1 : Connecting Digital Snake and MADI Device	19
Connection Example 2 : Dividing Output from a MADI Device to M-48 units.....	20
Connection Example 3 : Connecting a V-Mixer As a Monitor Console	21
Connection Example 4 : Long-distance Transmission of Optical Signals (1).....	22
Connection Example 5 : Long-distance Transmission of Optical Signals (2).....	23
Connection Example 6 : Configuring a 64-channel Input/Output System Using Two S-MADI Units	24
About the Remote Controller	26
Connecting a Dedicated Remote Controller.....	26
Connecting a Computer.....	26
Appendices.....	27
Main Specifications	27
Troubleshooting.....	27
Dimensions	28
Memo	29

Power Supply

Connect the included power cord to AC INPUT connector on rear panel. Be sure to use the included power cord for AC connection.

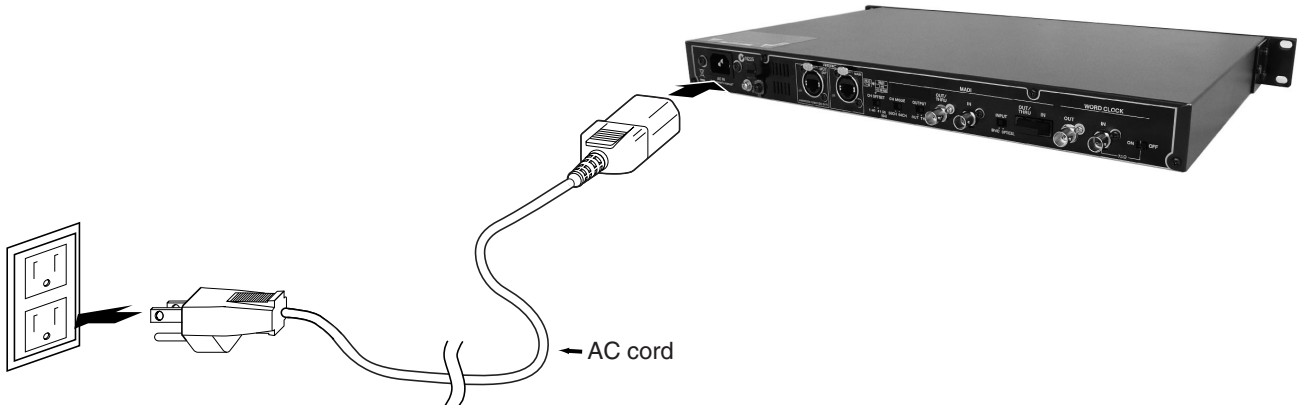

Be sure to connect the power plug only to a power outlet that meets the specifications given on the rating plate. The rating plate is located on the side of the unit. If it cannot easily be checked on the installed unit, refer to "Main Specifications" (p. 27).

About Cord Hook

Secure the power cord in place using the cord hook as shown below. This can help prevent power loss due to the plug being pulled out if the power cord is accidentally yanked.

1. Connect the power cord to the AC INPUT connector.



2. Secure the power cord in place with the cord hook.

Clamp the cord hook onto the power cord to secure it in place.



Turning the Power On and Off

Turning the Power On

Once the connections have been completed (p. 8), turn on power to your various devices in the order specified. By turning on devices in the wrong order, you risk causing malfunction and/or damage to speakers and other devices.

* This unit is equipped with a protection circuit. A brief interval (a few seconds) after power up is required before the unit will operate normally.

NOTE

When S-MADI is used as REAC Split device, turn on the power to connected REAC Master device and Slave device first. Then turn on the power to S-MADI. Refer to "REAC MAIN Indicator and SELECT Button" (p. 12) for REAC mode setting.

1. Connect the peripheral devices.

Connect the MADI and REAC devices. Make the connection with the power turned off for all devices, including the S-MADI.

2. Turn on the power to the S-MADI.

Set the POWER switch on the unit's front panel to ON to turn on the power to the S-MADI. The POWER indicator lights up when the power comes on.

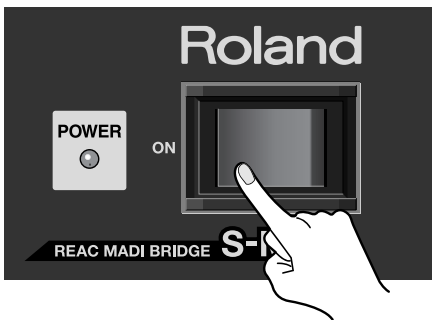

3. Turn on the power to the peripheral devices.

Turn on the power to the devices connected to the S-MADI.

Turning the Power Off

1. Turn off the power to the peripheral devices.

Turn off the power to the devices connected to the S-MADI.

2. Turn off the power to the S-MADI.

Set the POWER switch on the unit's front panel to OFF to turn off the power to the S-MADI. The POWER indicator goes dark when the power is turned off.

* When making connections to other equipment, to prevent malfunction or damage to speakers or other devices, be sure to lower the volume all the way before you switch on the power.

* After powering down all devices, detach the power sources.

* If you need to turn off the power completely, first turn off the POWER switch, then unplug the power cord from the power outlet.

About Installation

Important Notes When Installing

When installing the S-MADI, give attention to the points described below.

Intake Port and Exhaust Port of Cooling Fan

The S-MADI performs forced cooling by means of a cooling fan, and is provided with an intake port and an exhaust port at the locations shown below.

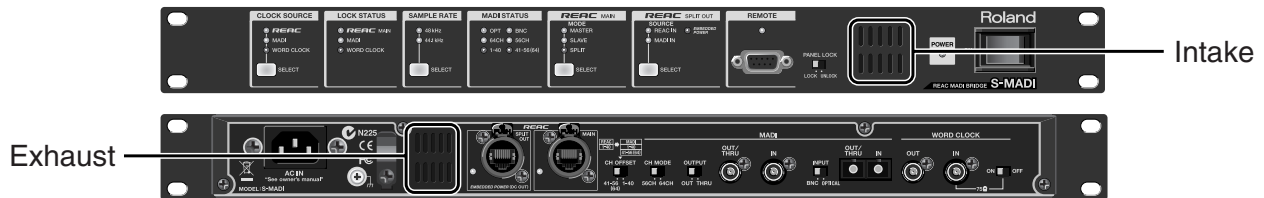

NOTE

Never obstruct the intake port or exhaust port. Doing so may cause the temperature of the unit's interior to rise, resulting in malfunction caused by heat. Install the unit so that at least 2 centimeters of space are left in front of the intake and exhaust ports.

* Use a vacuum cleaner to clear away any buildup of dust or the like at the intake port or exhaust port.

About Rack Mounting

You can mount the S-MADI in a 19-inch rack.

NOTE

When mounting the unit in a rack, observe the following precautions.

- Install in a well-ventilated location.
- Never obstruct the intake port or exhaust port on the S-MADI.
- Use an open-type rack to ensure that hot air from the exhaust port does not remain inside the rack.
- Never mount the unit in a sealed-type rack. Heated air inside the rack cannot escape, making efficient cooling impossible. If the unit must be mounted in a sealed rack, use a rack equipped with a ventilation fan.
- When using the unit while mounted in a portable rack, remove the front and rear rack covers before use to ensure that the intake and exhaust ports are not obstructed.
- When mounting the unit in a rack, never attach rubber feet to the unit's bottom panel. If they are already attached, then remove them.
- Use due caution when mounting the unit in a rack to ensure that your fingers don't become pinched.

About Rubber Feet

Attach the included rubber feet as required at the locations shown in the figure below.

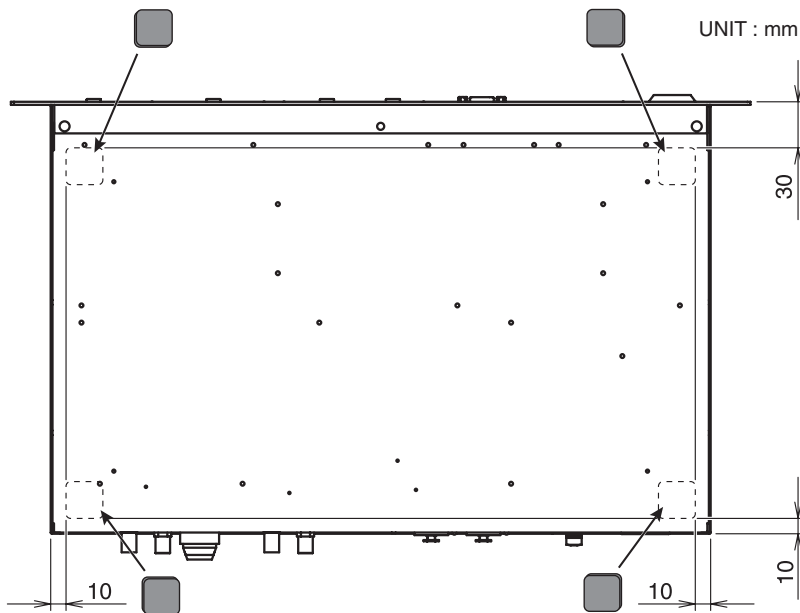
**NOTE**

When mounting the unit in a rack, be sure to detach the rubber feet.

Other Notes for Installation

- * When turning the unit upside-down, get a bunch of newspapers or magazines, and place them under the four corners or at both ends to prevent damage to the buttons and controls. Also, you should try to orient the unit so no buttons or controls get damaged.
- * When turning the unit upside-down, handle with care to avoid dropping it, or allowing it to fall or tip over.

Part Names and Functions

Front Panel

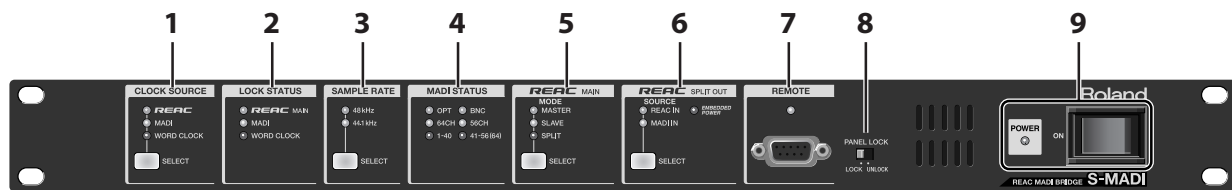

1. CLOCK SOURCE Indicator and SELECT Button

These set and display the sampling-clock source. Press the [SELECT] button to choose one of the clock sources described below. The indicator for the currently selected source lights up.

REAC

This sets the Clock Source to derive clock from the S-MADI's internal clock or any REAC master device connected to S-MADI's REAC MAIN port.

MADI

This sets the Clock Source to derive clock from a MADI device connected to S-MADI's MADI IN connector.

WORD CLOCK

This sets Clock Source to derive clock from a Word Clock generator or other device connected to S-MADI's WORD CLOCK IN connector.

2. LOCK STATUS Indicator

This displays the lock status of the sampling clock. It lights up when the clock source is locked normally. It flashes when the lock experiences a problem.

3. SAMPLE RATE Indicator and SELECT Button

These set and display the sampling rate. Press the SELECT button to choose either 44.1 kHz or 48 kHz. Select the sampling rate that matches the signals output from the source device.

This lights up when the clock source is locked normally. It flashes when the lock experiences a problem.

- * Selecting [REAC] as CLOCK SOURCE makes the SELECT button for SAMPLE RATE light up and allows you to change the setting.
- * You can press the SELECT button for SAMPLE RATE and change the setting only when it is illuminated. When dark, activating the button is disabled.
- * Selecting [MADI] or [WORD CLOCK] as CLOCK SOURCE automatically sets the S-MADI's sampling rate to match with MADI or WORD CLOCK input.

NOTE

The S-MADI supports sampling rates of 44.1 kHz and 48 kHz.

NOTE

The S-MADI cannot convert sampling rate. Sampling rate of all connected equipment must be identical.

4. MADI STATUS Indicator

This displays the status of MADI input and output.

OPT

This lights up when the INPUT switch on the rear panel is set to [OPTICAL].

BNC

This lights up when the INPUT switch on the rear panel is set to [BNC].

64CH

This lights up when the CH MODE switch on the rear panel is set to [64CH].

56CH

This lights up when the CH MODE switch on the rear panel is set to [56CH].

1-40

This lights up when the CH OFFSET switch on the rear panel is set to [1-40].

41-56

This lights up when the CH OFFSET switch on the rear panel is set to [41-56 (64)].

5. REAC MAIN Indicator and SELECT Button

These set and display the S-MADI's REAC mode. Press the SELECT button to choose one of the REAC modes described below.

MASTER

Audio signals are sent to slave and split devices. Also, audio signals are received from slave devices.

SLAVE

Audio signals are sent to and received from the master device.

SPLIT

Audio signals from the master device are received. (Split devices are "listening post" only and cannot send signals back into the system.)

- * You can press the SELECT button for REAC MAIN and change the setting only when it is illuminated. When dark, activating the button is disabled.
- * When [MADI] or [WORD CLOCK] is selected as CLOCK SOURCE, the [SELECT] button goes dark and the settings cannot be changed. The setting is automatically locked to [MASTER].

cf.

For information about mode settings, refer to "Connecting MADI/REAC Devices" (p. 19). To make the REAC system work properly, set the REAC modes of connected devices correctly.

6. REAC SPLIT OUT Indicator and SELECT Button

These set and display the source of the signal coming out from the REAC SPLIT OUT connector. Press the [SELECT] button and choose one of the sources described below.

REAC IN

This sends (thru-out) the signal coming in from the REAC MAIN connector.

MADI IN

This converts the signal coming in from the MADI IN connector to a REAC signal and outputs it.

EMBEDDED POWER

This indicator lights up when a device powered by REAC EMBEDDED POWER is connected to the REAC SPLIT OUT connector and the S-MADI is supplying power.

7. REMOTE Connector and Indicator

This is a D-Sub 9-pin (RS-232C) connector. You can connect a dedicated remote controller (S-4000R) or a computer installed with dedicated remote-control software (S-4000 RCS). Refer to "About the Remote Controller" (p. 26).

The indicator lights up when a remote-control device (S-4000R or computer) is connected to the REMOTE connector and the unit is under remote control.

8. PANEL LOCK Switch

This locks panel operation of the S-MADI. To lock the unit so that it does not accept operation, set this to [LOCK]. To enable operation, set it to [UNLOCK].

9. POWER Switch and Indicator

This turns the power to the S-MADI on and off. The indicator lights up when the power comes on.



For information about operation of the [SELECT] buttons, refer to "Operating the SELECT Buttons" (p. 16).

About Varipitch

The S-MADI does not support the pitch variation (by upto 12.5%) that is allowed by the MADI standard (Varipitch). When the CLOCK SOURCE selection is set to [MADI] or [WORD CLOCK], keep the frequency tolerance of your MADI source to +/- 40 ppm or less. Values exceeding +/- 40 ppm may produce noise or make synchronization with external equipment impossible.

What's REAC EMBEDDED POWER ?

This feature supplies power to connected REAC devices while simultaneously transmitting REAC signals over the same cable. This means the devices receiving power does not need to be connected to a power cable or a battery.

Rear Panel

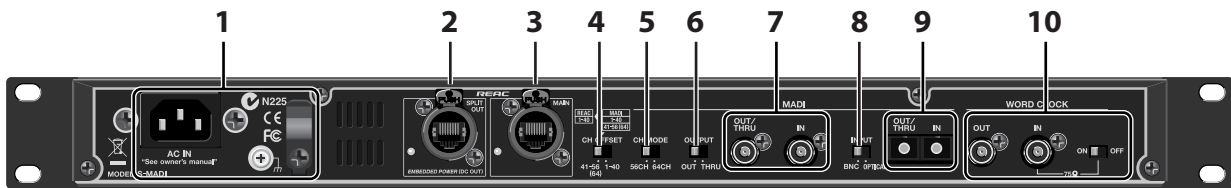

1. AC IN Connector and Cord Hook

This is for connecting the included power cable. Use the cord hook to secure the connected power cable in place (p. 8).

2. REAC SPLIT OUT Connector and Indicator

This connector is exclusively for output to REAC devices. The indicator flashes when communication with a connected REAC device has been established. It lights up steadily during standby.

For information on connecting a REAC device, refer to "Connecting MADI/REAC Devices" (p. 19).

- * The REAC SPLIT OUT connector supports REAC EMBEDDED POWER. It can supply power to M-48, S-0808, or other REAC-powered device via a REAC cable.

NOTE

The EMBEDDED POWER indicator on the front panel lights up when a device powered by REAC EMBEDDED POWER is connected and receiving power from the S-MADI.

NOTE

REAC master or slave devices cannot be connected to the REAC SPLIT OUT connector. Only a REAC split device or a REAC splitter such as an S-4000D or S-4000-SP can be connected.

3. REAC MAIN Connector and Indicator

This connector is for input and output of REAC signals. The indicator flashes when communication with a connected REAC device has been established. It lights up steadily during standby.

For information on connecting a REAC device, refer to "Connecting MADI/REAC Devices" (p. 19).

- * The REAC MAIN connector does not support REAC EMBEDDED POWER. Do not connect equipment that requires power to be supplied over the REAC cable.

NOTE

For REAC signals to be input and output correctly, the mode settings for all connected REAC devices must be made correctly. Use the [SELECT] button at REAC MAIN section to set appropriate REAC mode for S-MADI. For information about setting the REAC mode on your REAC devices, refer to the owner's manuals for the respective products.

4. CH OFFSET Switch

1-40

This connects REAC channels 1 through 40 with MADI channels 1 through 40. Signals on MADI input channels 41 and beyond are sent (thru-out) to MADI output channels 41 and beyond.

41-56 (64)

This connects MADI channels 41 through 56 or 64 with REAC channels 41 through 56 or 64.

5. CH MODE Switch

This sets the maximum number of MADI channels for input and output. Set this to correspond to the mode setting of connected MADI device.

NOTE

The connected MADI and REAC channels differ depending on the settings of the CH OFFSET and CH MODE switches. Refer to "Connected Channels for MADI and REAC" (p. 17).

6. OUTPUT Switch

To send (thru-out) the signal coming in from MADI IN connectors to the MADI OUT connectors, set this to [THRU]. To output MADI signal derived from REAC, set this to [OUT].

7. MADI Input/Output Connectors (BNC)

These are BNC-type connectors for MADI input and output. For input from the BNC connector, set the INPUT switch to [BNC].

NOTE

If the frequency tolerance is more than +/-40 ppm, the S-MADI may be unable to perform conversion accurately. If the frequency tolerance of the MADI device you are using is more than +/- 40 ppm, connect a word-clock generator or other external source device and set the CLOCK SOURCE to [WORD CLOCK].

8. INPUT Switch

This switch selects the connector for MADI input. Select either [BNC] or [OPTICAL].

- * MADI signals are output from both the BNC and optical MADI OUT connectors regardless of the setting of the INPUT switch.

9. MADI Input/Output Connectors (Optical)

These are optical-type connectors for MADI input and output. For input from optical connector, set the INPUT switch to [OPTICAL].

10. WORD CLOCK Connectors and 75 ohm Switch

These are connectors for word-clock input and output. You can connect a word-clock generator or other such external device to the WORD CLOCK IN connector for use as the sampling-clock source device.

- * The signal re-generated from the source (selected as CLOCK SOURCE on the front panel) is output from the WORD CLOCK OUT connector.
- * To terminate the input for WORD CLOCK at the S-MADI, set the 75 ohm switch to [ON].
- * To divide the signal coming into WORD CLOCK IN connector to other equipment as well, use a commercially available split connector (see photo below). In such cases, set the 75 ohm switch to [OFF].



About Ground Terminal

You can use the ground terminal shown below to connect the unit to an external ground.



However, never connect the unit to any of the following locations.

- Water pipes (may result in shock or electrocution)
- Gas pipes (may result in fire or explosion)
- Telephone-line ground or lightning rod (may be dangerous in the event of lightning)

Operating the SELECT Buttons

Press the [SELECT] buttons to change the mode of the S-MADI. The operation of the [SELECT] buttons is described below.

- * We are using CLOCK SOURCE selection as an example here. The same procedures are applicable to SAMPLE RATE, REAC MAIN and REAC SPLIT OUT selections.

NOTE

When PANEL LOCK switch is set to [LOCK], the SELECT buttons cannot be operated. To enable operation, set it to [UNLOCK].

1. Check the current mode.

The indicator for the currently selected mode is lighted up. Check the CLOCK SOURCE, SAMPLE RATE, REAC MAIN, and REAC SPLIT OUT indicators.

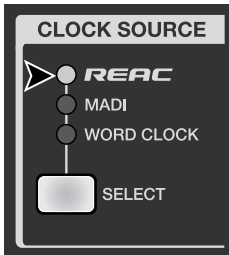

2. Select the mode to switch to.

Press the [SELECT] button to choose the mode. Pressing the [SELECT] button starts the switching operation of S-MADI. The indicator for the selected mode flashes during the switching operation.

- * Successively pressing the [SELECT] button makes the flashing indicator change in sequence, from top down.



3. Make sure the mode has changed.

The switching operation to the selected mode is completed after about 3 seconds. The indicator that was illuminated in step 1 goes dark, and the indicator that was flashing in step 2 stops flashing and stays steadily lit.

- * To prevent noise, sound is muted until the mode-change is complete.
- * You can cancel the switching operation before it finishes by pressing another [SELECT] button while the indicator is flashing.

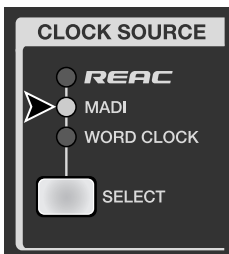

MEMO

You can operate the [SELECT] buttons for SAMPLE RATE and REAC MAIN only when CLOCK SOURCE is set to [REAC]. Operation is not possible when CLOCK SOURCE is set to [MADI] or [WORD CLOCK]. These [SELECT] buttons are dark when operation is not possible.

Connecting External Devices

Before Making MADI/REAC Connections

Connected Channels for MADI and REAC

You can input up to 64 channels to the MADI IN connectors on the S-MADI. The connected channels vary depending on the settings of the CH OFFSET and CH MODE switches, and the REAC SPLIT OUT setting.

You can make the settings from 1 through 6 shown below.

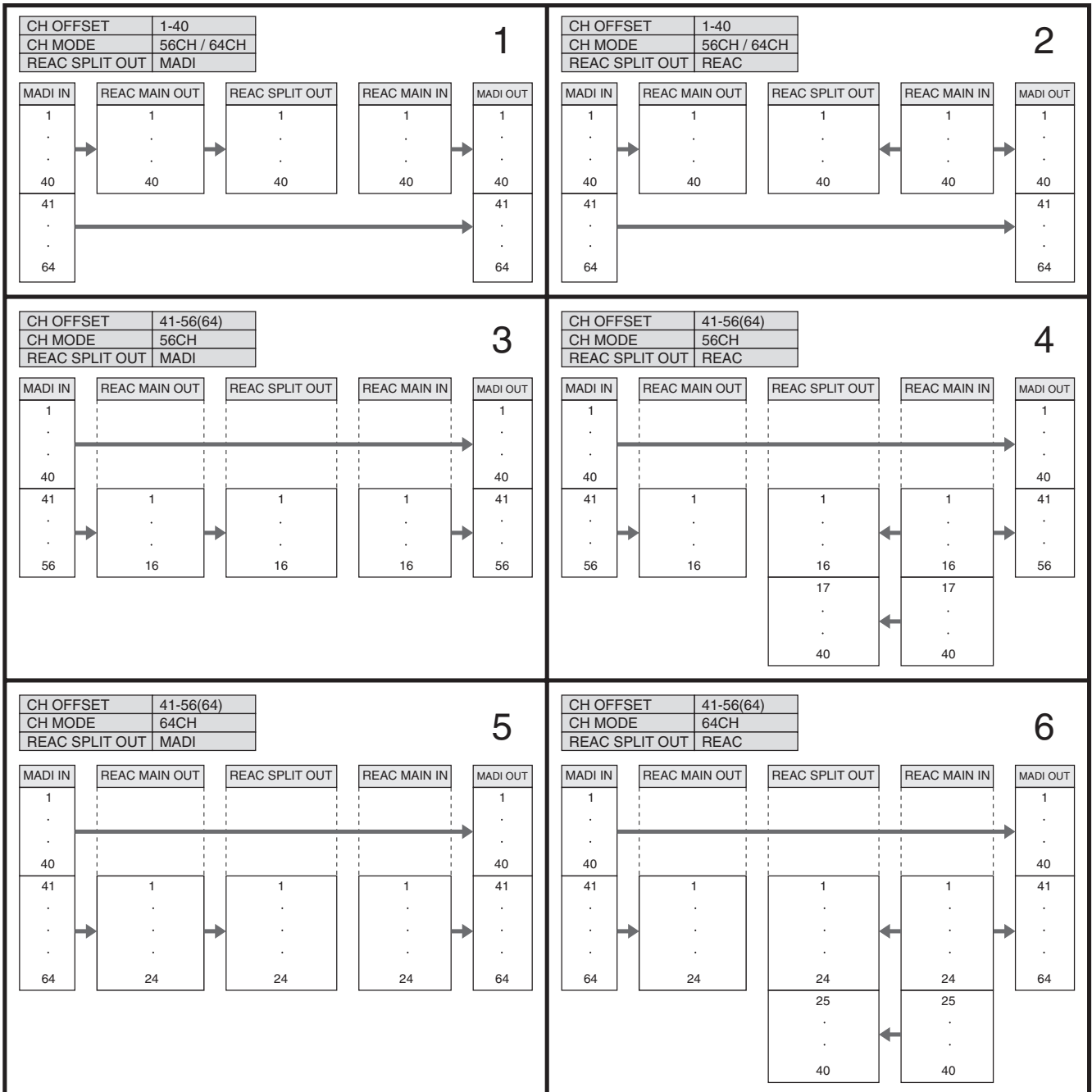

About Connection Cables

Observe the following points with respect to the cables used for connections.

- Never use cables with damaged or torn coverings.
- Never step on cables or subject them to undue stress.
- Never wind cables too tightly or bend them double.

Along with the points just described, also observe the following points for specific cable types.

Coaxial Cables (75 ohm, BNC connectors)

- No single cable should be longer than 100 meters.
- Use cables having connectors compliant with IEC 60169-8.
- The Canare L-5C2VS or equivalent is recommended.

Optical Cables (optical fiber, SC connectors, multi-mode, core diameter of 50/125 micro meters or 62.5/125 micro meters)

- No single cable should be longer than 2,000 meters.
- Use cables having connectors compliant with ISO/IEC 9314-3.

REAC Cables

- Ensure that the cables used for REAC connections conform to the Cat 5e (Enhanced Category 5) standard.
- No single cable should be longer than 100 meters.
- To maintain transmission quality, use of the following optional REAC cables is recommended.

100-meter cables: SC-W100S (cable only) or W100S-R (with reel)

20-meter cables: SC-W20F

- * Compared to analog transmission, digital transmission of audio signals by means of REAC (Roland Ethernet Audio Communication) is extremely resistant to external noise, but depending on the usage environment, in very rare instances, noise can occur. Selection of the wrong cable and incorrect cable handling are especially likely to cause noise.

About REAC Connector Covers

When using a commercially available Ethernet cable to connect a REAC device, fit the included REAC connector covers onto the REAC ports. Electromagnetic noise may be a problem if these are left unattached.

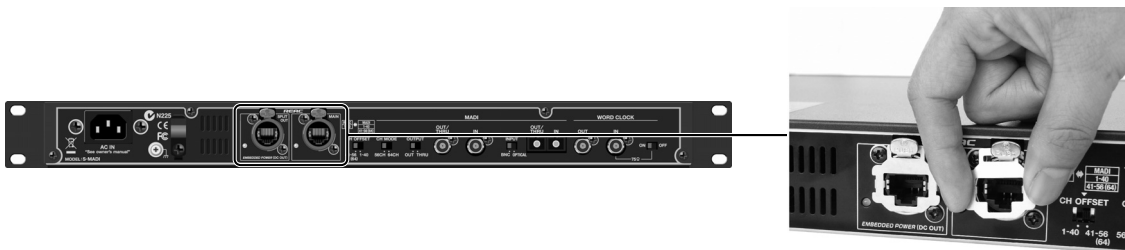

Attaching a REAC connector cover is not necessary when you're using an optional REAC cable (described above).

About Ferrite Cores

Two ferrite cores are included with the S-MADI. Attach the ferrite cores to the REAC cable being connected to the S-MADI. Clamp each ferrite core onto the cable at a location near the plug at the end of the cable, pressing down on the ferrite core until it clicks closed.

- * When attaching a ferrite core, be careful to avoid pinching your fingers.

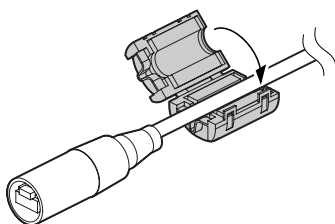

NOTE

When connecting a REAC device, use a cable that has ferrite cores attached to it.

Connecting MADI/REAC Devices

Connection Example 1 : Connecting Digital Snake and MADI Device

This sets up a digital snake as a stage unit and connects, via the S-MADI, a digital mixer equipped with MADI input and output. (This performs mutual MADI and REAC conversion.)

Connect the stage unit (in this figure, an S-4000S-3208) to the REAC MAIN connector on the S-MADI.

- * Operations such as adjusting the gain on the digital snake can be accomplished using a dedicated remote controller (S-4000R) connected to the S-MADI or using dedicated remote-control software (S-4000 RCS).
- * You cannot set Digital Snake's REAC Mode to Master when it is used in connection with S-MADI.

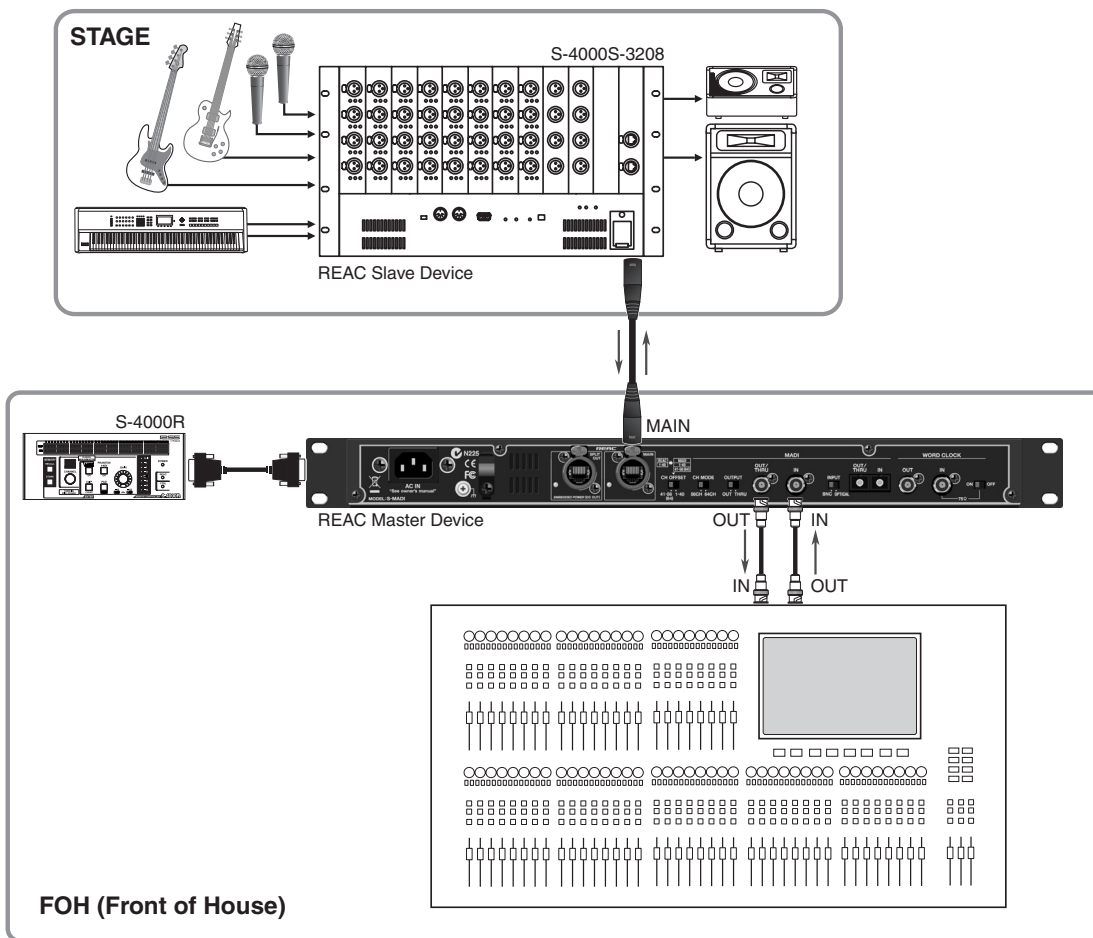

When making connections described here, set the modes and switches as shown below.

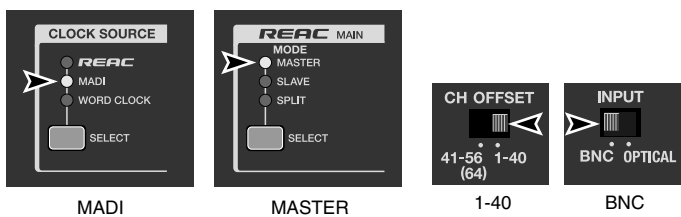

- * When CLOCK SOURCE is set to [MADI] or [WORD CLOCK], the S-MADI is automatically set to be the REAC master device. Set the digital snake as REAC slave device.
- * Selecting [MADI] or [WORD CLOCK] as CLOCK SOURCE automatically sets the sampling rate for the S-MADI to match the sampling rate being input.
- * When the MADI device is connected using an optical cable, set the INPUT switch to [OPTICAL].
- * Set CH MODE to correspond to the mode of the connected MADI device.

Connection Example 2 : Dividing Output from a MADI Device to M-48 units

You can configure a system that adds an M-48 live personal mixer to a live mixing system that has MADI output. You can also position an M-48 at Front of House for use as an output device providing monitor sound.

Signal routing to the M-48 units on stage is performed by the S-4000D (splitter and power distributor).

Connect the S-4000D at stage side to the REAC MAIN connector on the S-MADI. Connect the M-48 at Front of House to the REAC SPLIT OUT connector on the S-MADI.

* You can make settings for the M-48 units from dedicated remote-control software (S-4000 RCS) on the computer connected to the S-MADI.

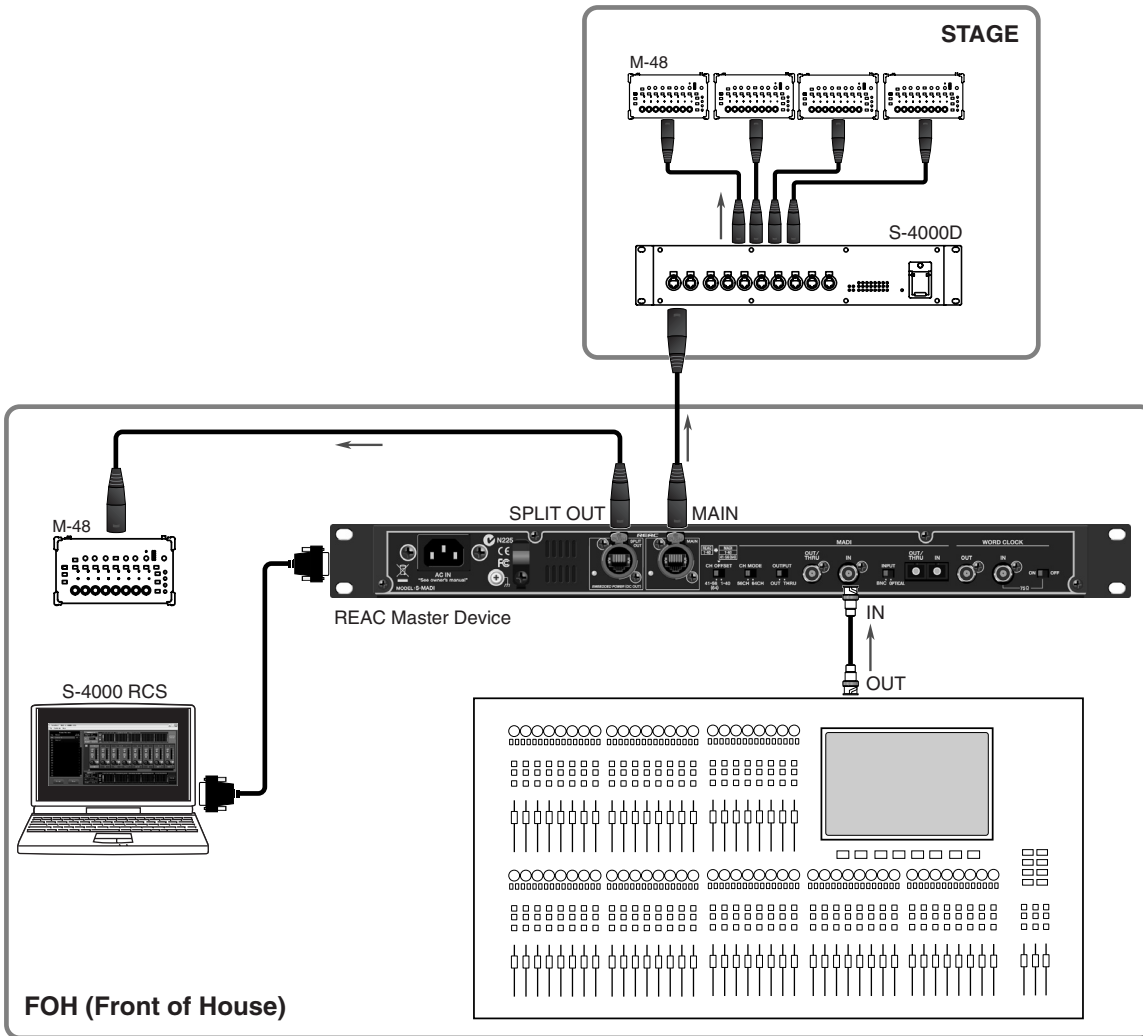

When making connections described here, set the modes and switches as shown below.

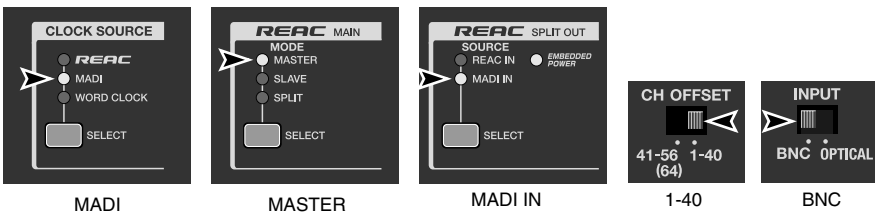

* When CLOCK SOURCE is set to [MADI] or [WORD CLOCK], the S-MADI is automatically set to be the REAC master device.

* Other precautions are the same as for "Connection Example 1."

Connection Example 3 : Connecting a V-Mixer As a Monitor Console

You can add a V-Mixer to the system in "Connection Example 1" for use as a monitor console.

Connect the REAC A connector on the V-Mixer to the REAC SPLIT OUT connector on the S-MADI, and connect the REAC B connector to the S-4000D.

- * When these connections are made, you can make settings of M-48 remotely from the V-Mixer.
- * Adjusting the gain on the digital snake or other settings can be accomplished using a dedicated remote controller (S-4000R) connected to the S-MADI or using dedicated remote-control software (S-4000 RCS).
- * You cannot set Digital Snake's REAC Mode to Master when it is used in connection with S-MADI.

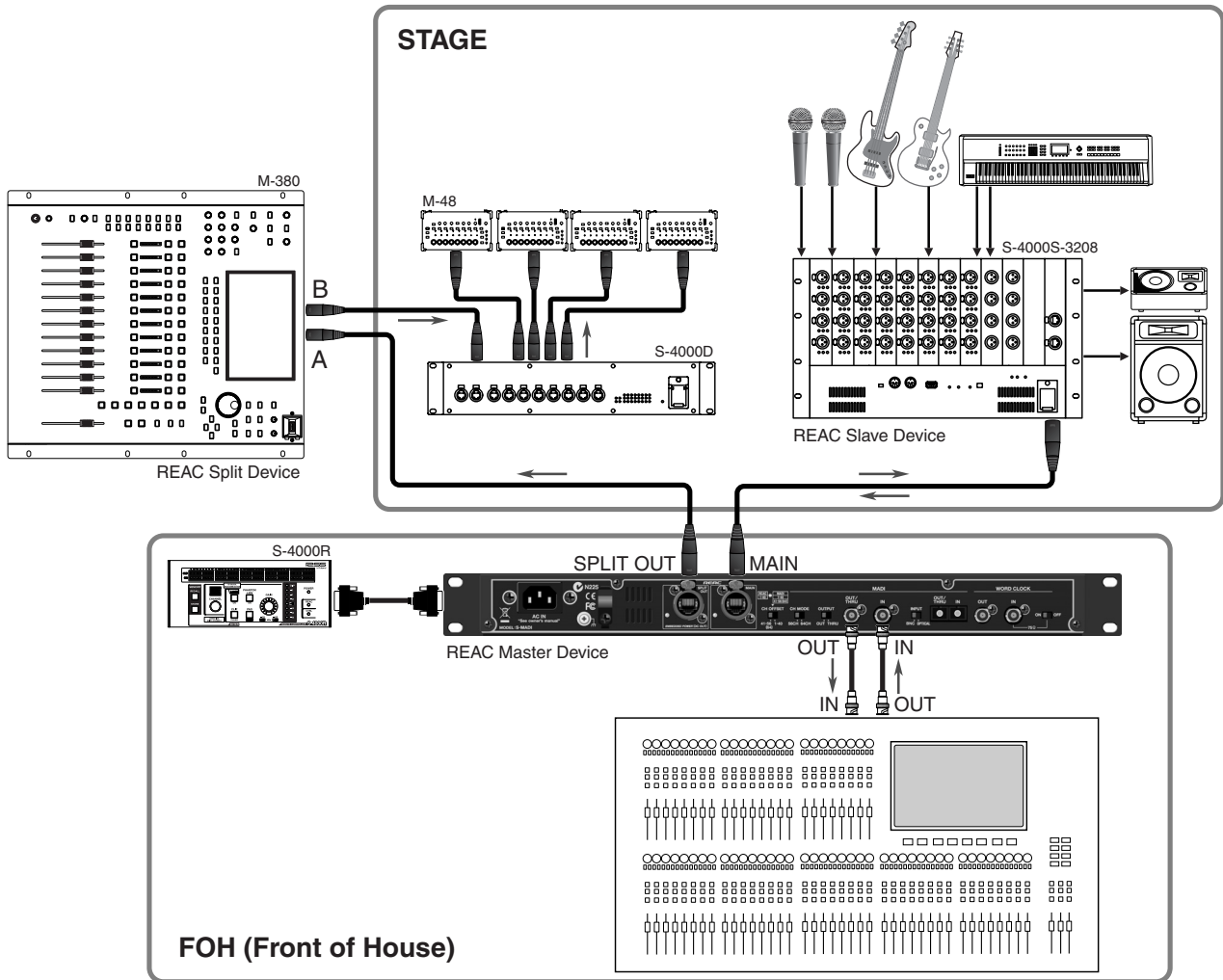

When making connections described here, set the modes and switches as shown below.

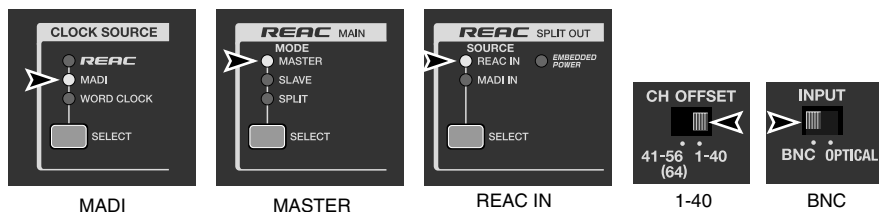

- * Set the V-Mixer as a REAC split device by setting its REAC SETUP to [MONITOR/BROADCAST].
- * Other precautions are the same as for "Connection Example 1."

Connection Example 4 : Long-distance Transmission of Optical Signals (1)

Using an optical cable for the MADi connection enables long-distance transmission. In situations such as when the recording room is located away from the Front of House or you are transmitting audio from a hall/stadium to an outside broadcasting van or the like, use optical cables.

* Some MADi recorders require dedicated MADi interfaces for connection with external equipment. Check owner’s manual of your MADi recorder before connection.

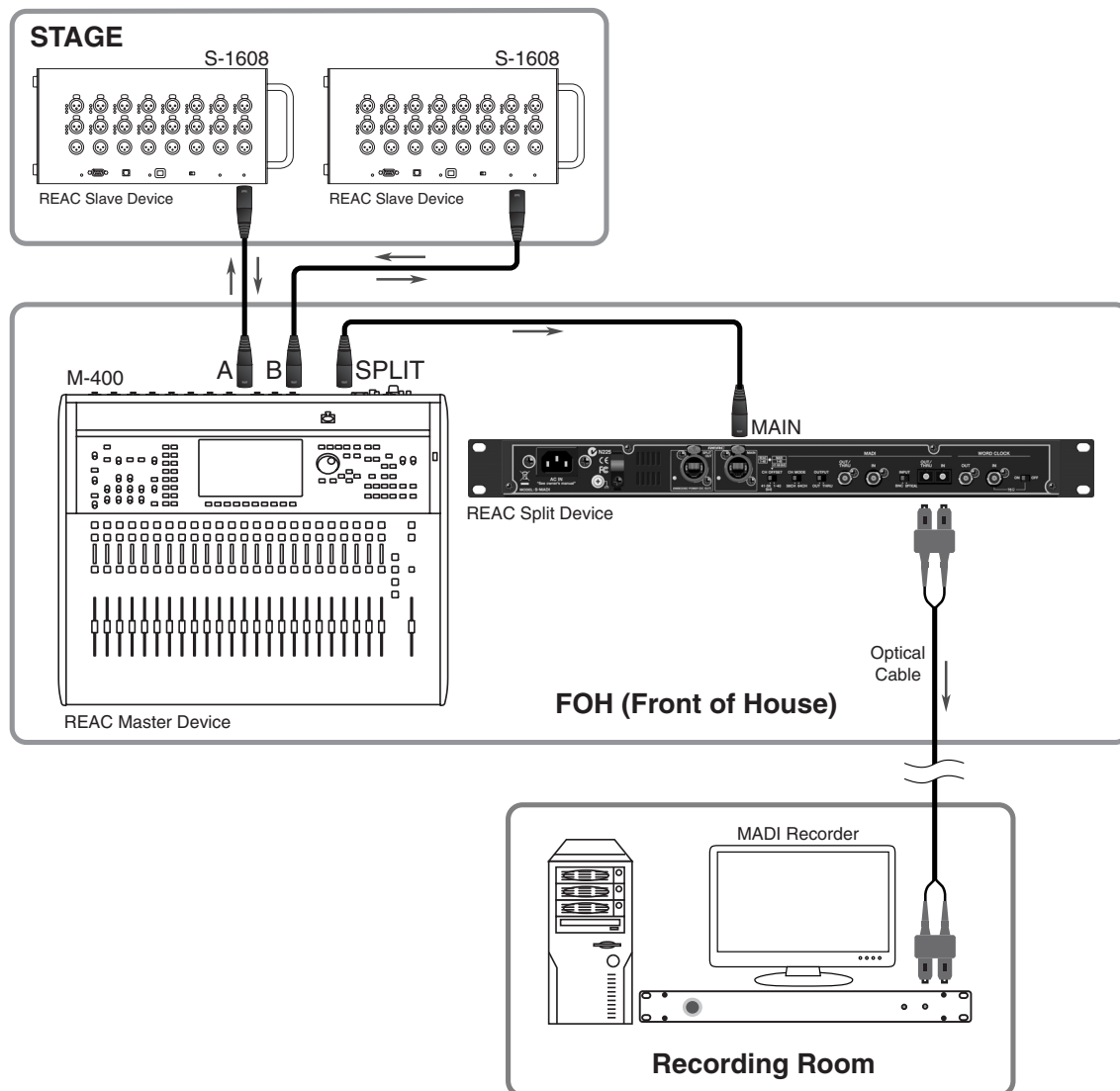

When making connections described here, set the modes and switches as shown below.

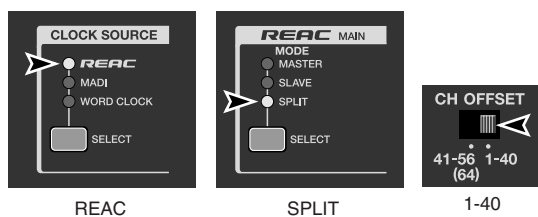

* Set the V-Mixer as REAC master device by setting its REAC SETUP to [FOH], the digital snake as REAC slave device, and the S-MADI as REAC split device.

Connection Example 5 : Long-distance Transmission of Optical Signals (2)

“Connection Example 4” is for recording a concert or the like, but as shown below, you can also make connections that do not go through a mixer. When you record the sound only, with no speaker output, place the digital snake near the sound sources and connect the recorder via the S-OPT units and S-MADI.

- * Conversion from analog to digital is accomplished near the sources, which can help prevent signal degradation.
- * Use an optical cable to connect the two S-OPT units. For information on how to make the connections, operation methods, and usable cables, refer to the owner’s manual for the S-OPT.
- * Adjusting the gain or other settings on the digital snake can be accomplished using a dedicated remote controller (S-4000R) or dedicated remote-control software (S-4000 RCS).
- * You cannot set Digital Snake’s REAC Mode to Master when it is used in connection with S-MADI.

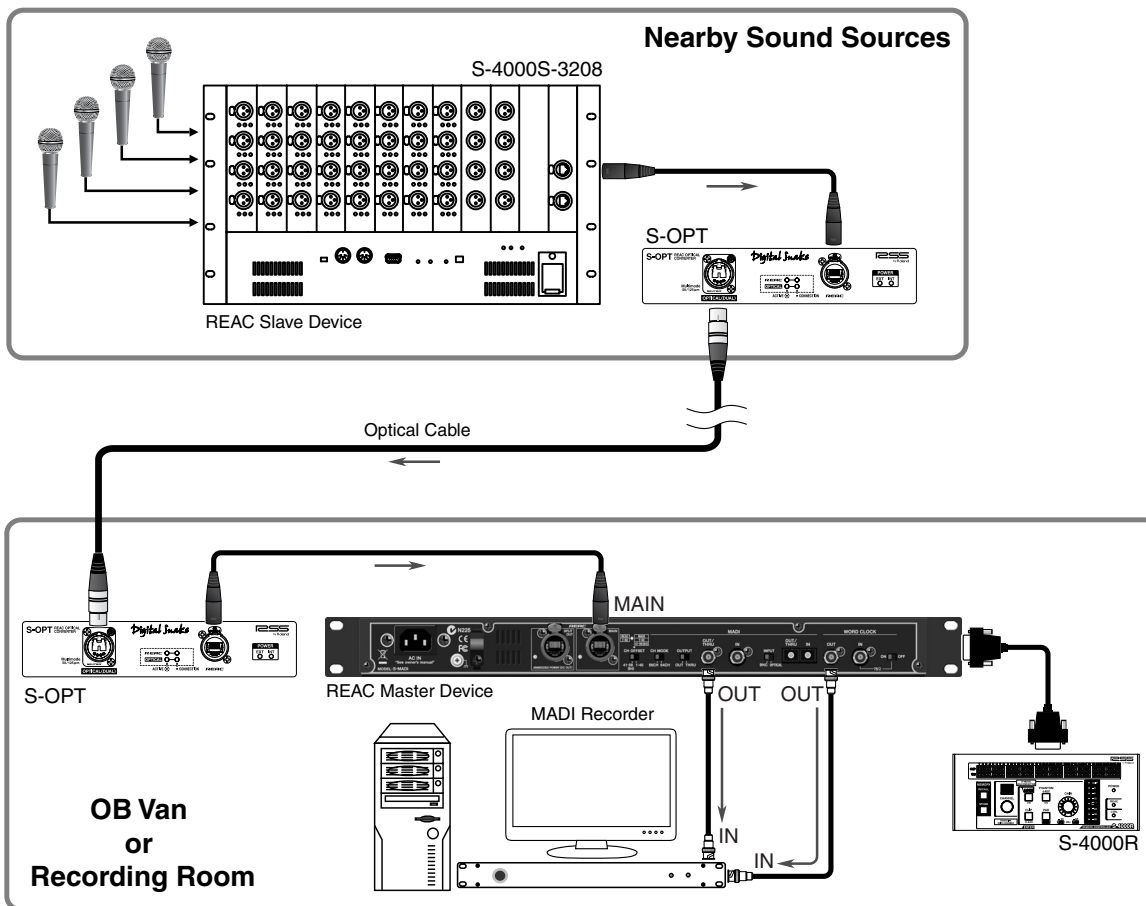

When making connections described here, set the modes and switches as shown below.

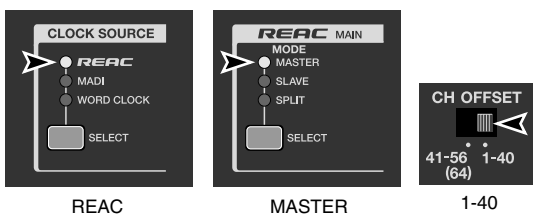

- * Set the S-MADI as REAC master device and the digital snake as REAC slave device.

Connection Example 6 : Configuring a 64-channel Input/Output System Using Two S-MADI Units

You can configure a system having 64 inputs and 64 outputs by linking two S-MADI units and connecting S-4000S units to each one.

* When the connections shown here are made, the following four types of input/output configurations for the S-4000S become necessary.

0 inputs/40 outputs (S-4000S-0040)

0 inputs/24 outputs (S-4000S-0024)

40 inputs/0 outputs (S-4000S-4000)

24 inputs/0 outputs (S-4000S-2400)

* For information on configuring S-4000S input/output modules, consult the Roland Service Stations shown on "Information" sheet.

* You cannot set Digital Snake's REAC Mode to Master when it is used in connection with S-MADI.

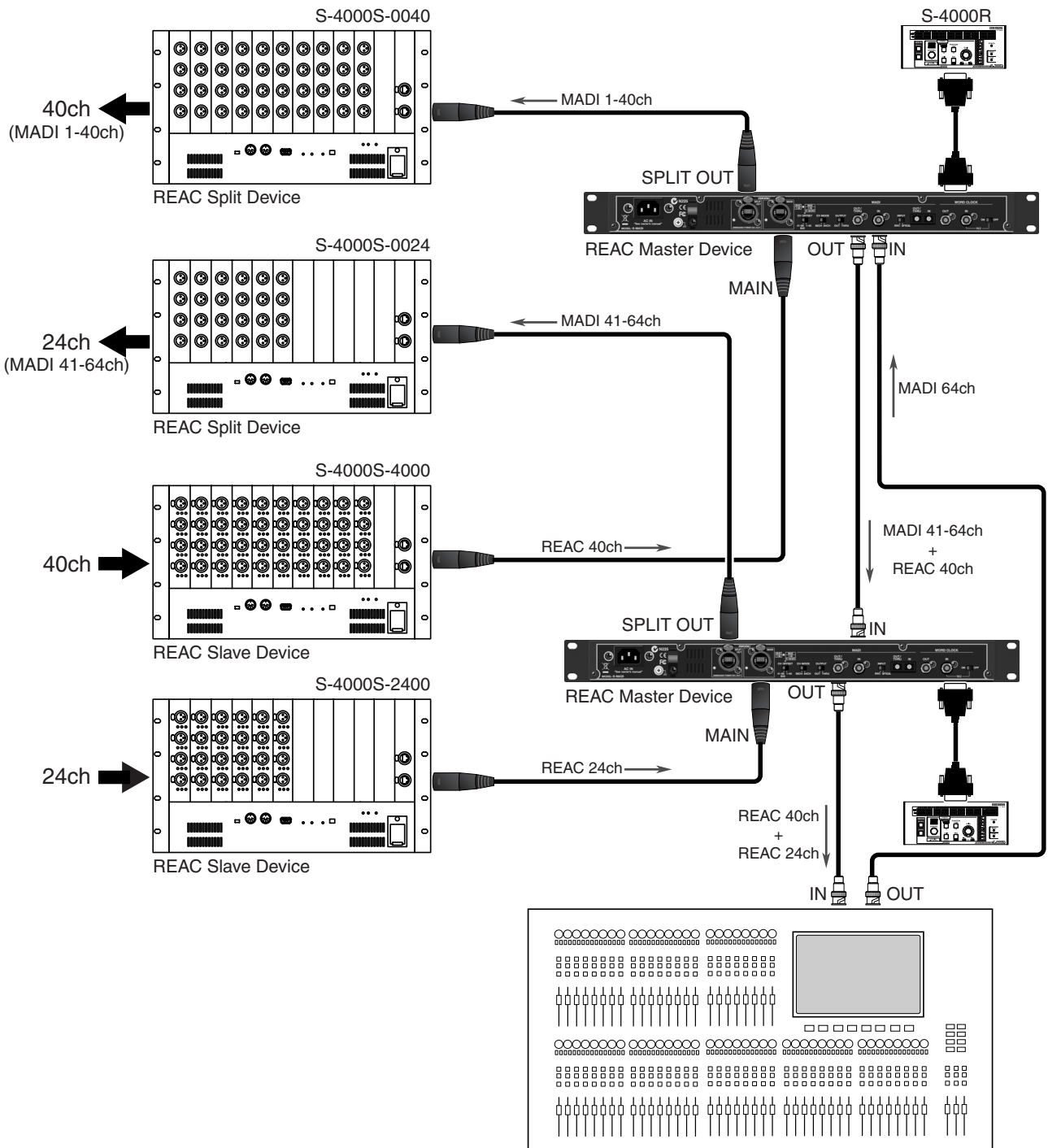

When making connections described here, set the modes and switches as shown below. Note that the first S-MADI (at the top of the figure) and the second S-MADI (at the bottom of the figure) have different CH OFFSET settings.

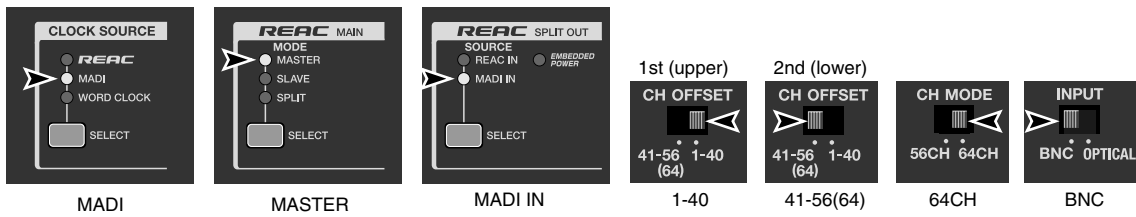

- * When CLOCK SOURCE is set to [MADI] or [WORD CLOCK], the S-MADI is automatically set to be the REAC master device.
- * Set the digital snake as REAC slave device or REAC split device, depending on which connector of S-MADI the digital snake is connected to.
- * When a sampling clock is supplied from an external device, set CLOCK SOURCE to [WORD CLOCK].
- * Other precautions are the same as for "Connection Example 1."

About the Remote Controller

Notes for Serial Connections

- * Use the accessory RS-232C cable of S-4000R for connection. If it's necessary to use longer or shorter cable, please purchase RS-232C cable (D-Sub 9pins/male-female/ straight type).
- * It is recommended to use a cable of 15 meters or shorter.
- * Connect S-4000R or computer to S-MADI, not to Digital Snake.

Connecting a Dedicated Remote Controller

You can connect a dedicated remote controller (S-4000R) for digital snake to the REMOTE connector on the S-MADI. The REMOTE indicator on the front panel lights up while S-MADI is receiving remote control from the S-4000R.

Connecting an S-4000R to the S-MADI lets you perform the following operations on the digital snake.

- Adjusting preamp gain
 - Turning phantom power on and off
 - Turning pads on and off
- * The S-4000R supports remote control up to 40 channels.
- * For information on the how to carry out remote control from the S-4000R, refer to the owner's manuals for the respective digital snake products.

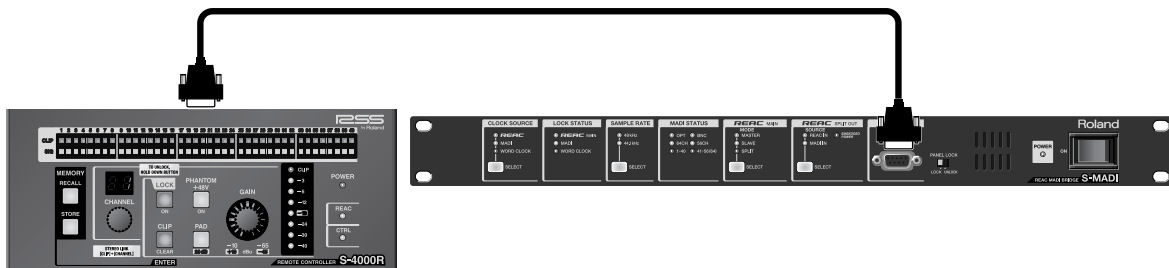

Connecting a Computer

You can connect a computer installed with dedicated remote-control software (S-4000 RCS) to the REMOTE connector on the S-MADI. The REMOTE indicator on the front panel lights up while S-MADI is receiving remote control from S-4000 RCS.

Connecting a computer installed with S-4000 RCS to the S-MADI lets you accomplish much the same operations as with a connected S-4000R unit. Using S-4000 RCS also provides the following advantages.

- You can view a list of the input levels on all channels.
- You can view a list of parameter settings (phantom power, pad, etc.) on all channels.
- You can save and recall up to 100 settings.
- If the computer has multiple RS-232C ports, you can control up to four systems.
- You can make settings of M-48 live personal mixer.

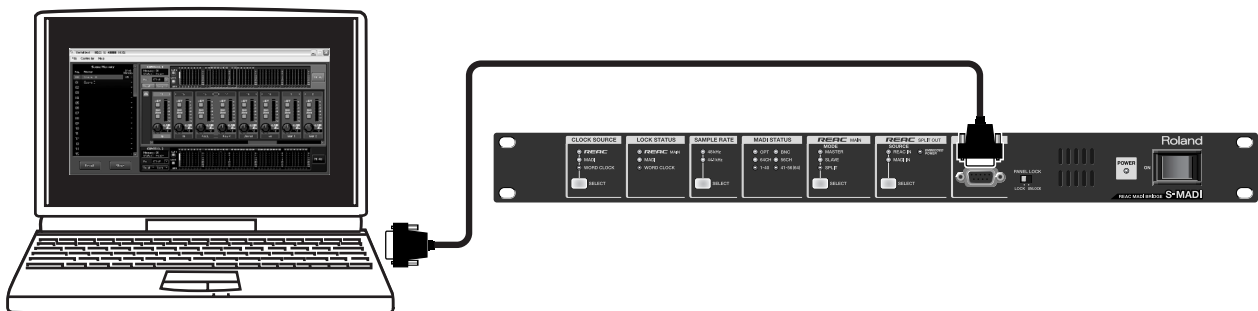

You can download S-4000 RCS from the following Roland website.

<http://www.rolandsystemsgroup.net/>

- * For more information on the computer's system requirements and operations, refer to the owner's manual for S-4000 RCS.

Appendices

Main Specifications

Signal Processing		Others	
Sample Rate	48 kHz / 44.1 kHz	Network Latency	450 microseconds (AD - S-MADI - DA : about 2.8 ms)
Frequency Tolerance	+/- 40 ppm	Power Supply	AC 115 V, 117 V, 220 V, 230 V, 240 V (50/60 Hz)
MADI Channel Mode	64 ch / 56 ch	Power Consumption	0.7 A : AC 115 V, 117 V 0.6 A : AC 220 V 0.5 A : AC 230 V, 240 V (at max output of REAC EMBEDDED POWER)
Connectors			
REAC Main	RJ-45 EtherCon Type x 1	Dimensions	482.0 (W) x 302.7 (D) x 44.0 (H) mm 19 (W) x 11-15/16 (D) x 1-3/4 (H) inches
REAC Split Out	RJ-45 EtherCon Type x 1		
Word Clock In / Out	BNC Type x 2	Weight	3.5 kg / 7 lbs 12 oz
MADI In / Out	Coaxial : BNC type x 2	Operation Temperature	0 to +40 degrees Celsius +32 to +104 degrees Fahrenheit
	Optical : SC Duplex type x 1		
Remote	9-pin D-Sub type x 1	Accessories	Power Cord, REAC Connector Cover x 2, Ferrite Core x 2, Rubber Foot x 4, Owner's Manual

* In the interest of product improvement, the specifications and/or appearance of this unit are subject to change without prior notice.

Troubleshooting

The SELECT buttons have no effect.

Is the PANEL LOCK switch set to [LOCK]?

To enable operation, set this to [UNLOCK]. No operation is possible when it is set to [LOCK].

WORD CLOCK input and output contains errors.

The word-clock output of the S-MADI is a signal that the S-MADI re-generates internally based on the signal being input as the clock source. This means that slight difference may occur between the input and output. When splitting signals input from a source device to other devices, use a commercially available split connector (p. 15).

Input and output are not possible.

Is the sampling rate of the connected equipment set to 44.1 kHz or 48 kHz?

The S-MADI supports sampling rates of 44.1 kHz and 48 kHz. Set all connected equipment to the identical sampling rate, matched to the sampling-rate of the S-MADI.

NOTE

The S-4000H does not support 44.1 kHz or 48 kHz, and so it cannot be connected to the S-MADI.

REAC input is not output from MADI OUT.

When the unit is set to [THRU], signals input to the MADI IN connector are sent from the MADI OUT connector (thru-out). When you want to convert REAC input into MADI output, set the OUTPUT switch to [OUT].

Output contains noise.

Does the frequency tolerance of the sampling clock in the input MADI signal exceed +/- 40 ppm?

If the value is exceeding +/- 40 ppm, S-MADI cannot convert accurately. Connect an external word-clock generator or other such device, and change the CLOCK SOURCE setting to [WORD CLOCK].

Transmission to/from digital snake is not possible.

Is a suitable cable used to make the connection?

Refer to "About Connection Cables" (p. 18) and use a suitable connection cable.

Have the REAC mode settings (master, slave, or split) been made correctly on the respective equipment?

Refer to "Connection Example 1" through "Connection Example 6" and make the correct REAC mode settings.

Memo

Memo



For EU Countries

This product complies with the requirements of EMC 2004/108/EC and LVD 2006/95/EC.

For the USA

FEDERAL COMMUNICATIONS COMMISSION RADIO FREQUENCY INTERFERENCE STATEMENT

This equipment has been tested and found to comply with the limits for a Class B digital device, pursuant to Part 15 of the FCC Rules. These limits are designed to provide reasonable protection against harmful interference in a residential installation. This equipment generates, uses, and can radiate radio frequency energy and, if not installed and used in accordance with the instructions, may cause harmful interference to radio communications. However, there is no guarantee that interference will not occur in a particular installation. If this equipment does cause harmful interference to radio or television reception, which can be determined by turning the equipment off and on, the user is encouraged to try to correct the interference by one or more of the following measures:

- Reorient or relocate the receiving antenna.
- Increase the separation between the equipment and receiver.
- Connect the equipment into an outlet on a circuit different from that to which the receiver is connected.
- Consult the dealer or an experienced radio/TV technician for help.

This device complies with Part 15 of the FCC Rules. Operation is subject to the following two conditions:

- (1) this device may not cause harmful interference, and
- (2) this device must accept any interference received, including interference that may cause undesired operation.

Unauthorized changes or modification to this system can void the users authority to operate this equipment. This equipment requires shielded interface cables in order to meet FCC class B Limit.

For Canada

NOTICE

This Class B digital apparatus meets all requirements of the Canadian Interference-Causing Equipment Regulations.

AVIS

Cet appareil numérique de la classe B respecte toutes les exigences du Règlement sur le matériel brouilleur du Canada.

For C.A. US (Proposition 65)

WARNING

This product contains chemicals known to cause cancer, birth defects and other reproductive harm, including lead.

For China

有关产品中所含有害物质的说明

本资料就本公司产品中所含的特定有害物质及其安全性予以说明。

本资料适用于 2007 年 3 月 1 日以后本公司所制造的产品。

环保使用期限



此标志适用于在中国国内销售的电子信息产品，表示环保使用期限的年数。所谓环保使用期限是指在自制造日起的规定的期限内，产品中所含的有害物质不致引起环境污染，不会对人身、财产造成严重的不良影响。环保使用期限仅在遵照产品使用说明书，正确使用产品的条件下才有效。不当的使用，将会导致有害物质泄漏的危险。

产品中有毒有害物质或元素的名称及含量

部件名称	有毒有害物质或元素					
	铅(Pb)	汞(Hg)	镉(Cd)	六价铬(Cr(VI))	多溴联苯(PBB)	多溴二苯醚(PBDE)
外壳(壳体)	×	○	○	○	○	○
电子部件(印刷电路板等)	×	○	×	○	○	○
附件(电源线、交流适配器等)	×	○	○	○	○	○

○：表示该有毒有害物质在该部件所有均质材料中的含量均在 SJ/T11363-2006 标准规定的限量要求以下。

×：表示该有毒有害物质至少在该部件的某一均质材料中的含量超出 SJ/T11363-2006 标准规定的限量要求。

因根据现有的技术水平，还没有什么物质能够代替它。

For EU Countries



- UK** This symbol indicates that in EU countries, this product must be collected separately from household waste, as defined in each region. Products bearing this symbol must not be discarded together with household waste.
- DE** Dieses Symbol bedeutet, dass dieses Produkt in EU-Ländern getrennt vom Hausmüll gesammelt werden muss gemäß den regionalen Bestimmungen. Mit diesem Symbol gekennzeichnete Produkte dürfen nicht zusammen mit dem Hausmüll entsorgt werden.
- FR** Ce symbole indique que dans les pays de l'Union européenne, ce produit doit être collecté séparément des ordures ménagères selon les directives en vigueur dans chacun de ces pays. Les produits portant ce symbole ne doivent pas être mis au rebut avec les ordures ménagères.
- IT** Questo simbolo indica che nei paesi della Comunità europea questo prodotto deve essere smaltito separatamente dai normali rifiuti domestici, secondo la legislazione in vigore in ciascun paese. I prodotti che riportano questo simbolo non devono essere smaltiti insieme ai rifiuti domestici.
Ai sensi dell'art. 13 del D.Lgs. 25 luglio 2005 n. 151.
- ES** Este símbolo indica que en los países de la Unión Europea este producto debe recogerse aparte de los residuos domésticos, tal como esté regulado en cada zona. Los productos con este símbolo no se deben depositar con los residuos domésticos.
- PT** Este símbolo indica que nos países da UE, a recolha deste produto deverá ser feita separadamente do lixo doméstico, de acordo com os regulamentos de cada região. Os produtos que apresentem este símbolo não deverão ser eliminados juntamente com o lixo doméstico.
- NL** Dit symbool geeft aan dat in landen van de EU dit product gescheiden van huishoudelijk afval moet worden aangeboden, zoals bepaald per gemeente of regio. Producten die van dit symbool zijn voorzien, mogen niet samen met huishoudelijk afval worden verwijderd.
- DK** Dette symbol angiver, at i EU-lande skal dette produkt opsamles adskilt fra husholdningsaffald, som defineret i hver enkelt region. Produkter med dette symbol må ikke smides ud sammen med husholdningsaffald.
- NO** Dette symbolet indikerer at produktet må behandles som spesialavfall i EU-land, iht. til retningslinjer for den enkelte regionen, og ikke kastes sammen med vanlig husholdningsavfall. Produkter som er merket med dette symbolet, må ikke kastes sammen med vanlig husholdningsavfall.
- SE** Symbolen anger att i EU-länder måste den här produkten kasseras separat från hushållsavfall, i enlighet med varje regions bestämmelser. Produkter med den här symbolen får inte kasseras tillsammans med hushållsavfall.
- FI** Tämä merkintä ilmaisee, että tuote on EU-maissa kerättävä erillään kotitalousjätteistä kunkin alueen voimassa olevien määräysten mukaisesti. Tällä merkinnällä varustettuja tuotteita ei saa hävittää kotitalousjätteiden mukana.
- HU** Ez a szimbólum azt jelenti, hogy az Európai Unióban ezt a terméket a háztartási hulladéktól elkülönítve, az adott régióban érvényes szabályozás szerint kell gyűjteni. Az ezzel a szimbóllummal ellátott termékeket nem szabad a háztartási hulladék közé dobni.
- PL** Symbol oznacza, że zgodnie z regulacjami w odpowiednim regionie, w krajach UE produktu nie należy wyrzucać z odpadami domowymi. Produktów opatrzonych tym symbolem nie można utylizować razem z odpadami domowymi.
- CZ** Tento symbol udává, že v zemích EU musí být tento výrobek sbíráán odděleně od domácího odpadu, jak je určeno pro každý region. Výrobky nesoucí tento symbol se nesmí vyhazovat spolu s domácím odpadem.
- SK** Tento symbol vyjadruje, že v krajinách EÚ sa musí zber tohto produktu vykonávať oddelene od domového odpadu, podľa nariadení platných v konkrétnej krajine. Produkty s týmto symbolom sa nesmú vyhazovať spolu s domovým odpadom.
- EE** See sümbol näitab, et EL-i maades tuleb see toode olemprügist eraldi koguda, nii nagu on igas piirkonnas määratletud. Selle sümboliga märgitud tooteid ei tohi ära visata koos olmeprügiga.
- LT** Šis simbolis rodo, kad ES šalyse šis produktas turi būti surenkamas atskirai nuo buitinių atliekų, kaip nustatyta kiekviename regione. Šiuo simboliu paženklinoti produktai neturi būti išmetami kartu su buitinėmis atliekomis.
- LV** Šis simbols norāda, ka ES valstīs šo produktu jāievāc atsevišķi no mājsaimniecības atkritumiem, kā noteikts katrā reģionā. Produkts ar šo simbolu nedrīkst izmest kopā ar mājsaimniecības atkritumiem.
- SI** Ta simbol označuje, da je treba proizvod v državah EU zbirati ločeno od gospodinjjskih odpadkov, tako kot je določeno v vsaki regiji. Proizvoda s tem znakom ni dovoljeno odlagati skupaj z gospodinjjskimi odpadki.
- GR** Το σύμβολο αυτό υποδηλώνει ότι στις χώρες της Ε.Ε. το συγκεκριμένο προϊόν πρέπει να συλλέγεται χωριστά από τα υπόλοιπα οικιακά απορρίμματα, σύμφωνα με όσα προβλέπονται σε κάθε περιοχή. Τα προϊόντα που φέρουν το συγκεκριμένο σύμβολο δεν πρέπει να απορρίπτονται μαζί με τα οικιακά απορρίμματα.